

12¢

MARCH 2026

TURTLEMAN

FILES A PATENT

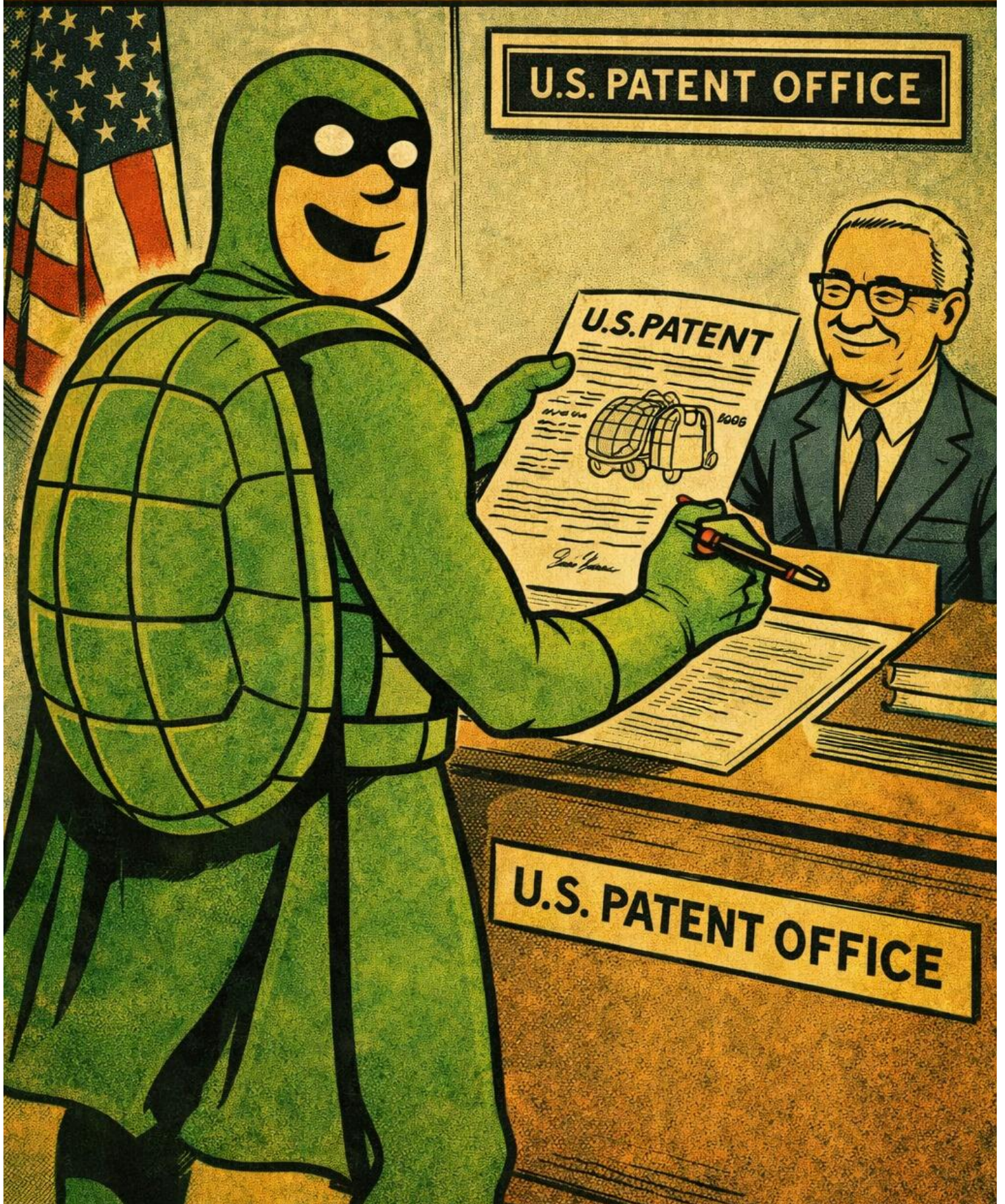

TURTLE MAN

Created by Ian A. and Viv Maxwell

© 2025 MXXI Holdings Pty Ltd.
All rights reserved.

Based on actual lies: any resemblance
between any characters in this comic with
real living people is a miracle.

HATERS BE HATERS.
TO ALL YOUSE HATERS OUT
THERE, WE LOVE YA!

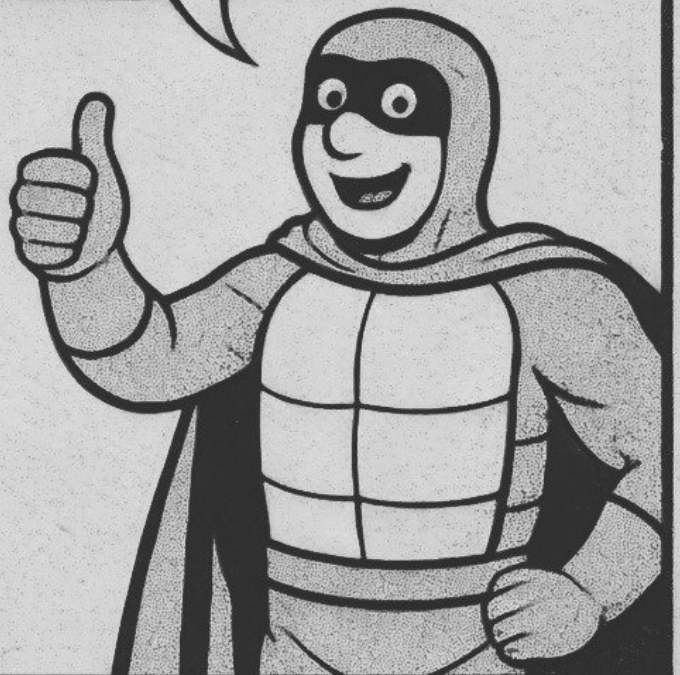

TURTLEMAN FILES A PATENT

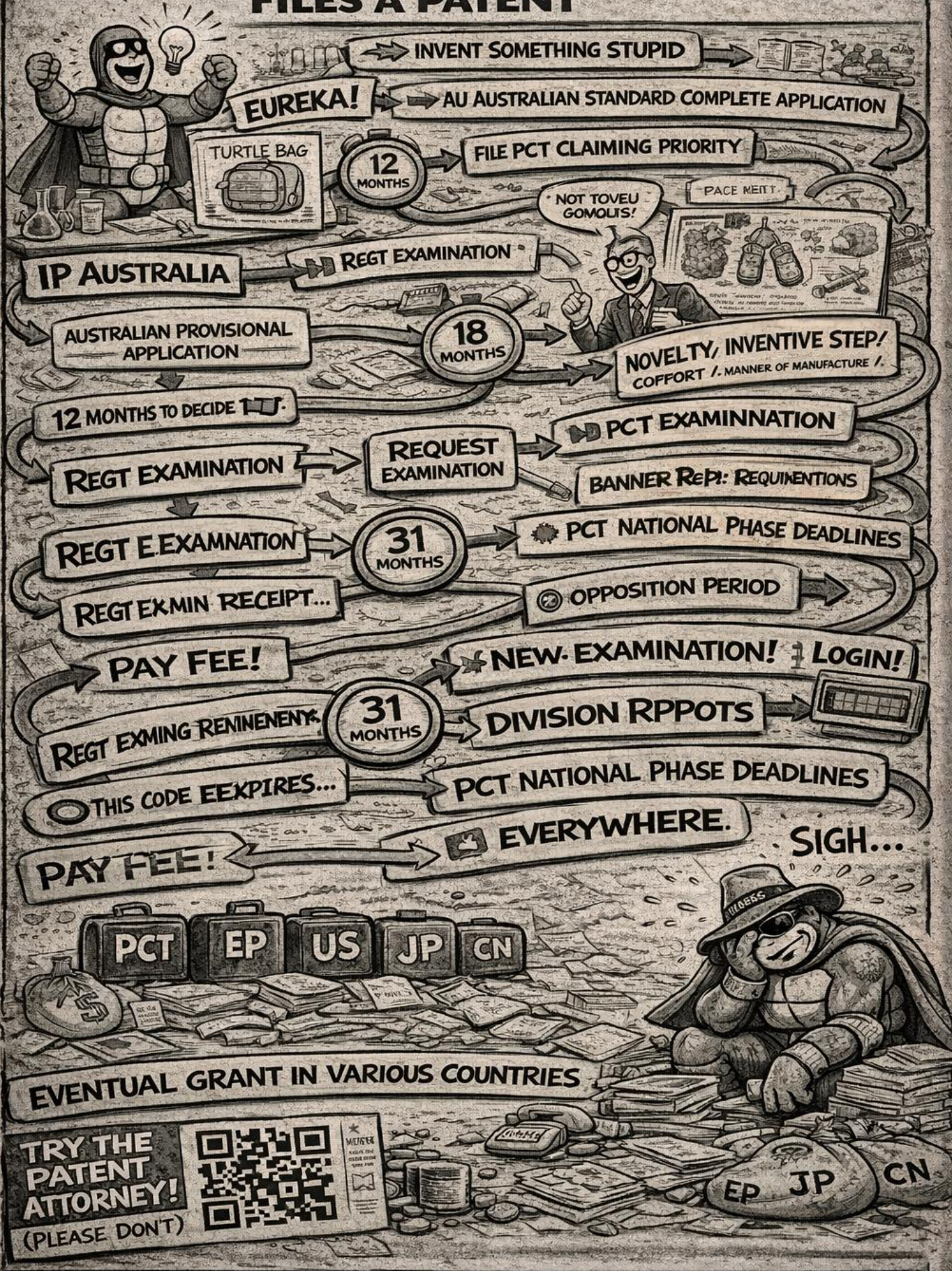

TRY THE PATENT ATTORNEY!
(PLEASE DON'T)



WOLFE
SOLUS THE
WORLD'S FIRST
PATENT FIRM

UNITED STATES
PATENT AND TRADEMARK OFFICE

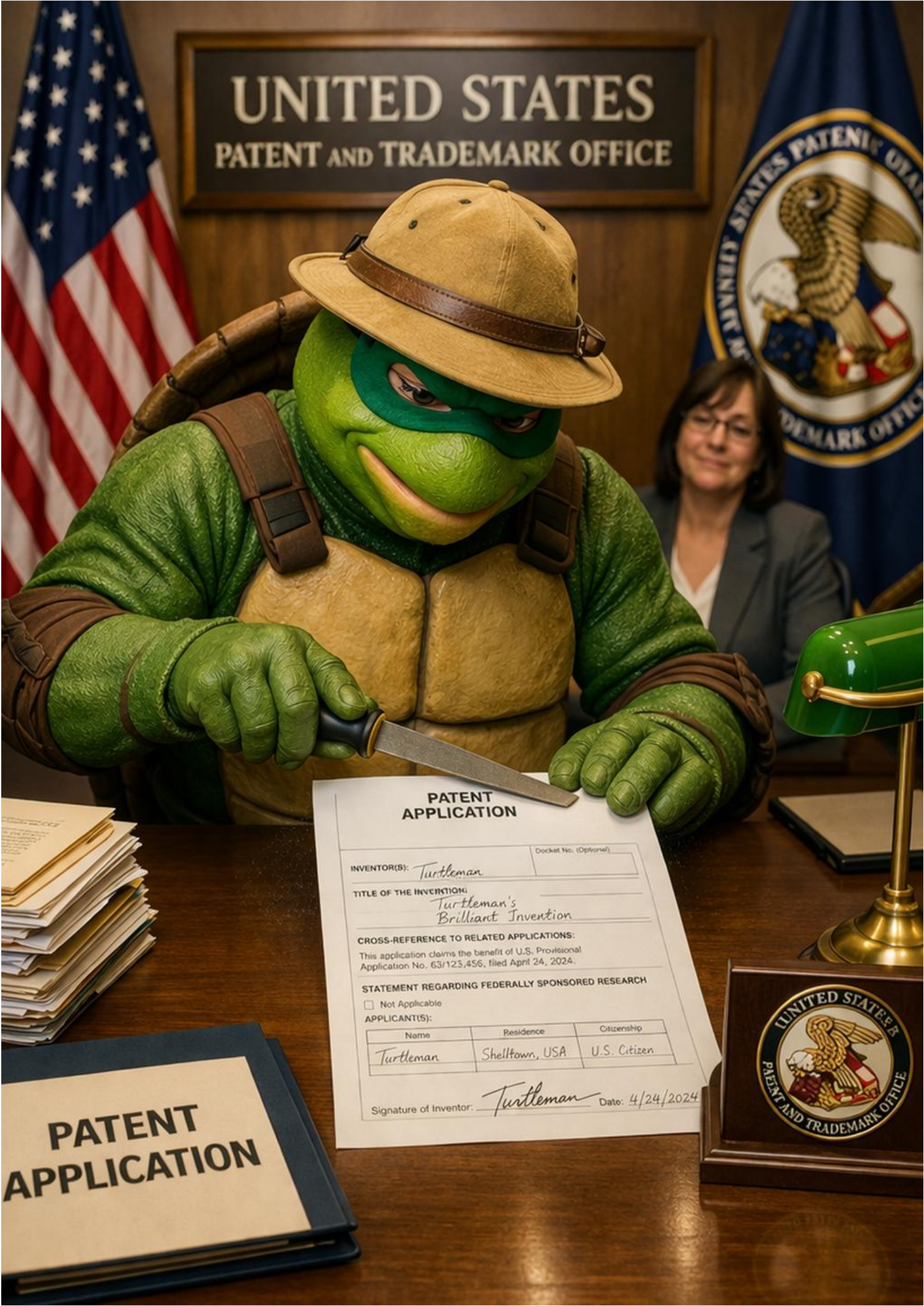

PATENT APPLICATION

INVENTOR(S): *Turtleman* Docket No. (Optional)

TITLE OF THE INVENTION:
Turtleman's Brilliant Invention

CROSS-REFERENCE TO RELATED APPLICATIONS:
This application claims the benefit of U.S. Provisional Application No. 63/125,456, filed April 24, 2024.

STATEMENT REGARDING FEDERALLY SPONSORED RESEARCH
 Not Applicable

APPLICANT(S):

Name	Residence	Citizenship
<i>Turtleman</i>	<i>Shelltown, USA</i>	<i>U.S. Citizen</i>

Signature of Inventor: *Turtleman* Date: *4/24/2024*

PATENT APPLICATION



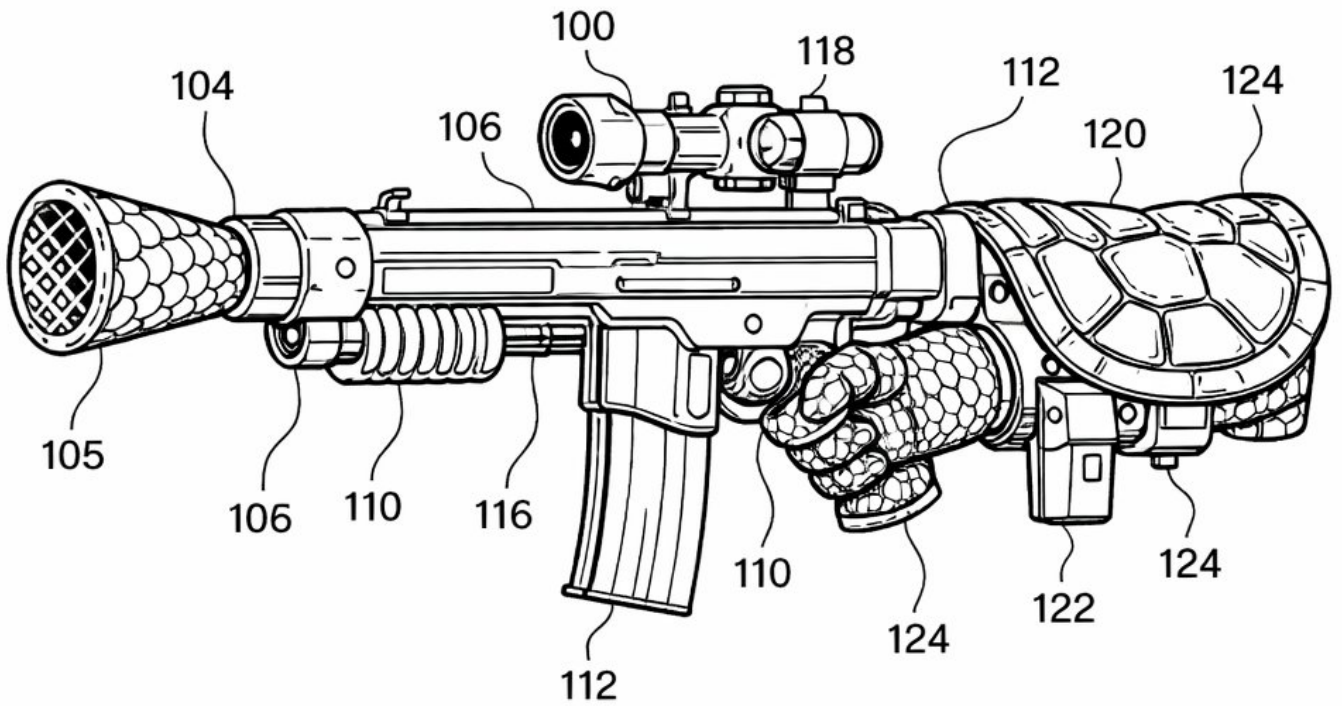

- | | |
|---------------------------------|--------------------------------|
| 100 Turtleman gun | 102 Barrel |
| 104 Net launcher | 105 Net ittancher |
| 106 Turtle shell shoulder stock | 106 Turtle shell sholder stock |
| 108 Pump-action grip | 112 Turtleman glove |
| 110 Turtle hand grip | 120 Utility belt pouch |
| | 124 Strap |

FIG. 1

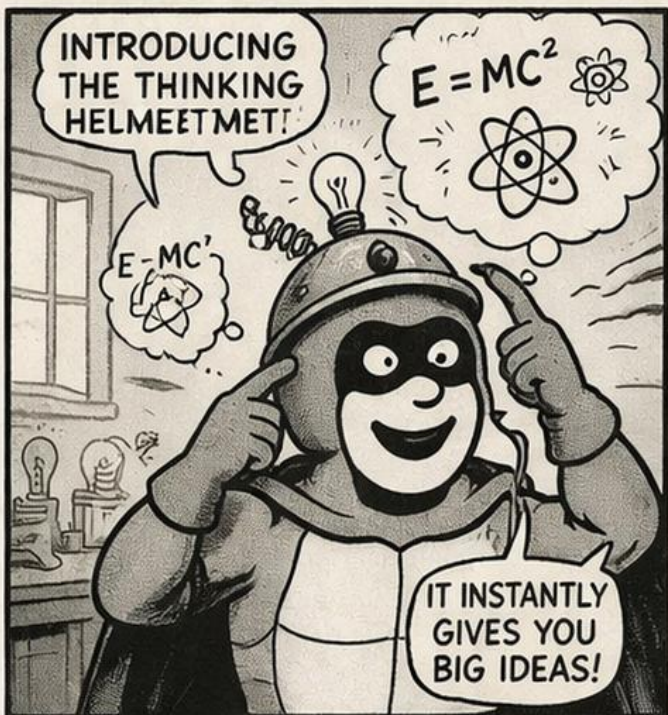
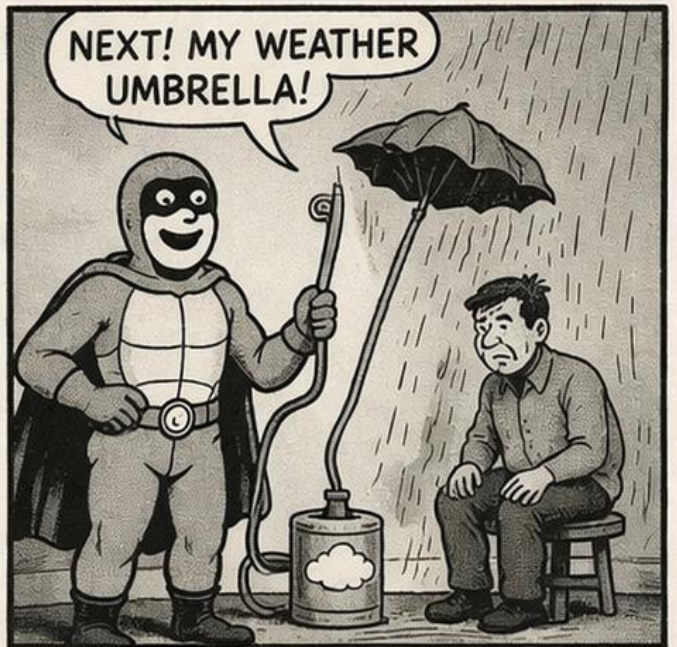
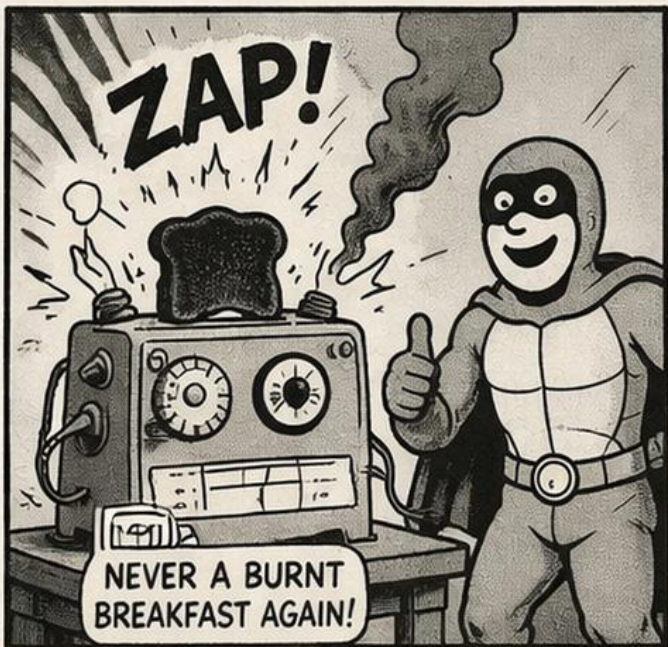
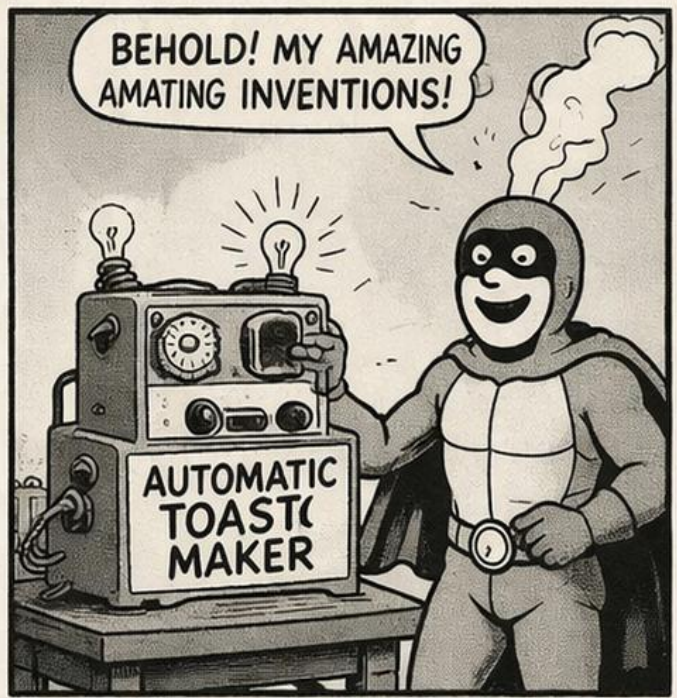

INVENTION OF THE DAY

THE TOP 5 ALL-TIME INVENTIONS!

THEY REALLY HIT THE MARK!

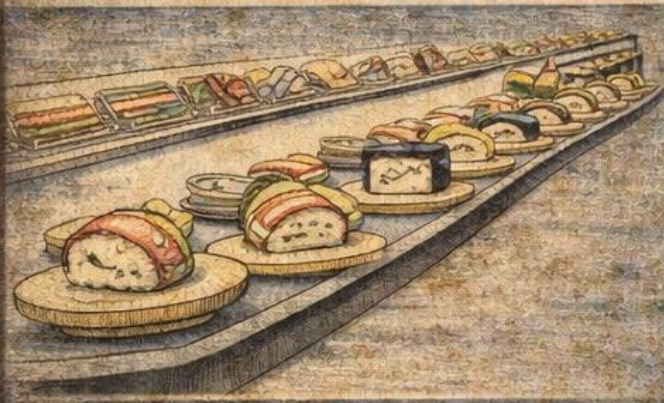

SUSHI TRAIN

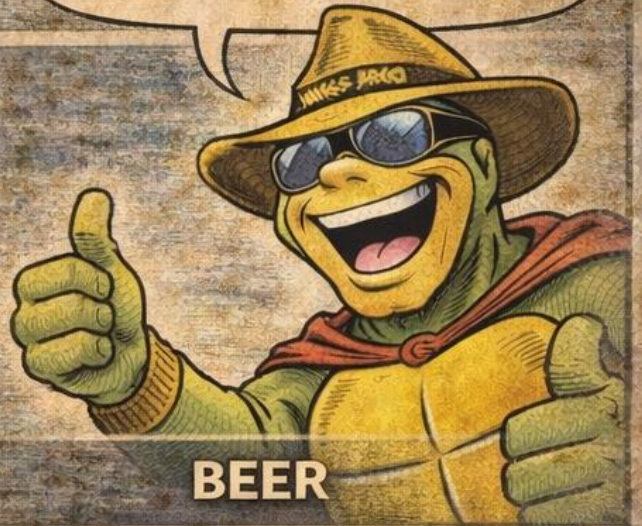

BEER



READING GLASSES



BEER



OP'S SMOKES



THE ADJUSTABLE BEARD TRIMMER

HONOURABLE MENTION ~ LUBE

INVENTION OF THE DAY

THE 5 ALL-TIME WORST INVENTIONS!



THE SHOPPING TROLLEY

WHAT WERE THEY THINKING?!



THE SPLADE.



THE FONDUE SET

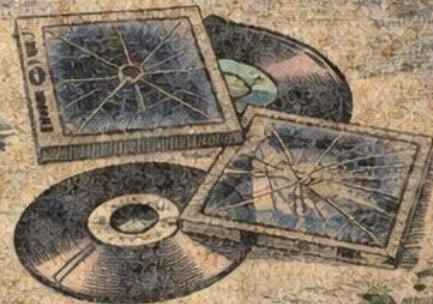

THE CD COVER:



THE STEAM MOP



HONOURABLE MENTION —
THE WINE BOTTLE PUMP

INVENTION OF THE DAY

BIKE HELMET TRANSMITTER!

ALERTS DRIVERS TO NEARBY CYCLISTS!

Safer streets for everyone!



ACTIVATES CAR TOLL TAGS!

ACTIVATES CAR TOLL TAGS!

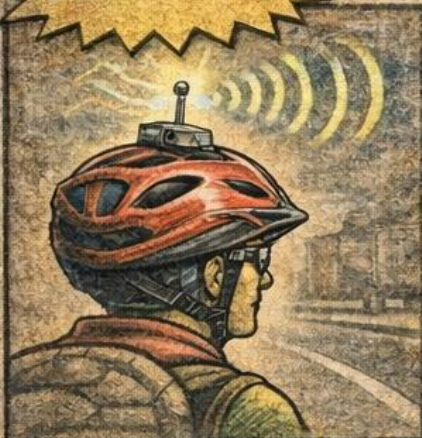

HELMET TRANSMITS SIGNAL!



CAR'S TOLL TAG BEEPS LOUDER AS IT GETS CLOSER!



ALERTS DRIVER TO NEARBY CYCLISTS!

REDUCES BIKE ACCIDENTS!
SAVES LIVES!

- ✓ REDUCES BIKE ACCIDENTS!
- ✓ SAVES LIVES!

INVENTION OF THE DAY



TURING SCALE!

SEE HOW HUMAN-LIKE YOUR AI REALLY IS!

See how human your new AI "really" is



1. ANALYSIS DIAL

2. ANALYSIS TUBES

3. BLINKY LIGHTS

4. RESULT PRINTER

Wow! Are you sure you're really a robot?

Sure thing, buddy?

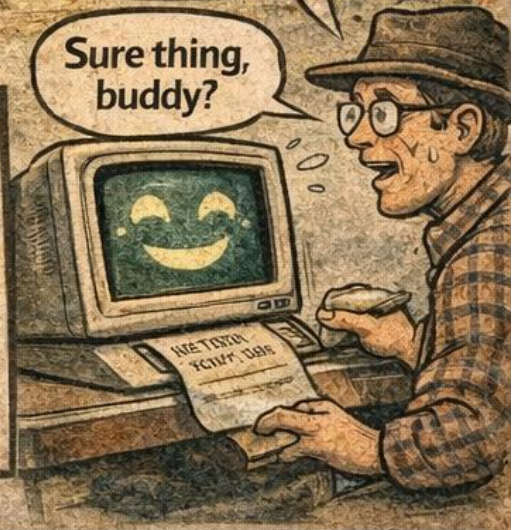

FOOL-PROOF RESULTS!

- ▶ 0-10% TOTAL BOT
- ▶ 11-40% PRETTY SUS
- ▶ 41-70% KIND OF HUMAN
- ▶ 71-90% VERY HUMAN
- ▶ 91-100% REAL HUMAN

- TOTAL BOT
- PRETTY SUS
- KIND OF HUMAN
- VERY HUMAN
- REAL HUMAN

INVENTION OF THE DAY

VELCRO SOCK RACK!

EMPTY THE DRYER IN SECONDS!

It grabs all your socks at once!



NO MORE LOOSE SOCKS!



VELCRO STRIP

HOLDS ALL YOUR SOCKS



GRAB 'EM WHEN NEEDED

THE NON-FUZZY HOOK SIDE OF VELCRO® STRIP!



VELCRO STRIP



HOLDS ALL YOUR SOCKS



GRAB 'EM WHEN NEEDED

INVENTION OF THE DAY

HOMEOPATHIC GLUTEN DROPS!

MAKES GLUTEN-FREE FOOD TASTE LIKE THE REAL THING!

No gluten, no problem!



RICE PASTA



GLUTEN INTÉTRANT!



GLUTEN FREE



WHEAT PASTA

MAGIC DROPS!



- ✓ TURN RICE PASTA INTO THE REAL DEAL!
- ✓ TURN GLUTEN-FREE BEER INTO FULL-FLAVOURED BREW!
- ✓ INDISTINGUISHABLE FROM GLUTEN-LOADED Verson!

INVENTION OF THE DAY

PRE-FRIED HALOUMI!

NO ONE EATS IT RAW, WHY CAN'T YOU BUY IT READY-MADE?



This **CHANGES EVERYTHING!!**

- Too hard
- Turns to goo
- Different texture



★★★ **REGULATOR APPROVED**

- **Mechanism**
- Haloumi is a tough milk protein network.
- Natural pH and calcium keep it solid.
- Pre-fried coating stabilises before packaging.



INVENTION OF THE DAY

PRAM DRONE!

FOLLOW YOUR PHONE,
NOT YOUR PRAM!

SUPERB!



- YOUR BABY FOLLOWS YOU!
- HOVERS OVER STAIRS AND STEPS!



LEAVE PROBLEMATIC PRAMS BEHIND!

INVENTION OF THE DAY

LOCATION-ENABLED LEGO® BLOCKS!

TRACK LEGO POSITIONS IN REAL-TIME!

Find the right piece,
every time!



TWO MODES OF USE:

1. TEST

...Follower Mode re-existing design



...Creator Mode NEW DESIGNS & SHARING!



AUTOMATIC CAD UPLOAD!



- ✓ PASSIVE LOCATION CHIPS!
- ✓ REAL-TIME TRACKING!
- ✓ BOOST CREATIVITY & ACCURACY!

INVENTION OF THE DAY

ADVANCED EYEBROW TRIMMER!

IMPROVES EYEBROW APPEARANCE!

Looks just like natural eyebrow hair!



Nanobot-blended quantum enzymes!



STANDARD TRIM

Blunt cut... doesn't look like hair!



TAPERED CUT END

Fine-tapered cuts with natural look!



STANDARD

Blunt cut tss!



ADVANCED TRIM

Fine-tape-like cuts with eprtnore hian!

NEXT-GEN TRIMMING!

- ✓ TAPERS EYEBROW HAIRS!
- ✓ LOOKS LIKE THEY GREW THAT WAY!
- ✓ BRINGS OUT YOUR EYES!

INVENTION OF THE DAY

3-D CHOCOLATE PRINTER!

PRINT ANYTHING...IN CHOCOLATE!

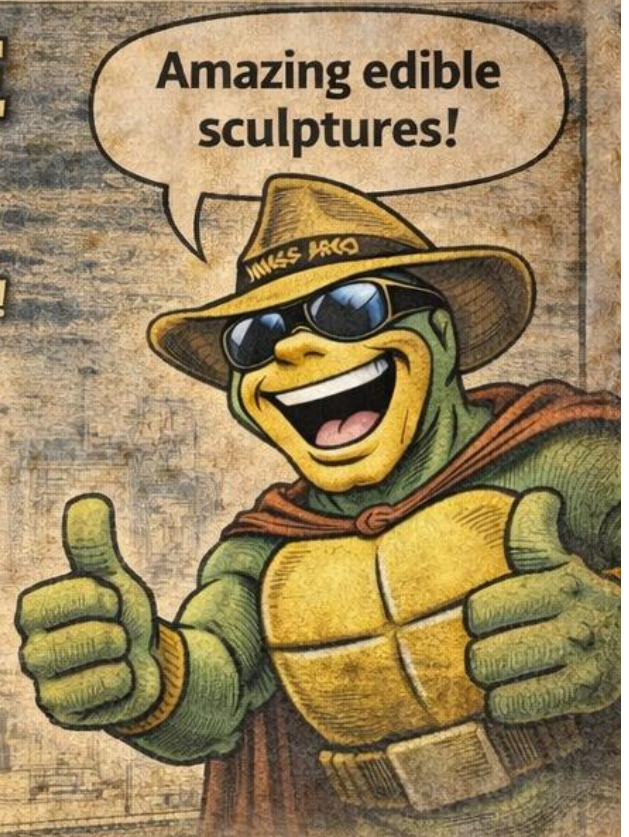

PRINT CUSTOM
CHOCOLATE HEADS!



PRINT A CHOCOLATE MEAL!



PERFECT CHOCOLATE GIFTS!

**PRINT IN
CHOCOLATE!**

- ✓ DELICIOUS EDIBLE GIFTS!
- ✓ IMAGINE THE POSSIBILITIES!
- ✓ WOW YOUR FRIENDS!

INVENTION OF THE DAY

PINEHEDGE!

NATURE MEETS ANTIQUITY!

Trees shaped like Stonehenge!



TRIMMING TRACTOR!



PINE HEDGE STONES!

WORLD-FAMOUS
NATURAL ATTRACTION!

**SECURE
PEACE OF MIND!**

- ✓ PRECISION-TRIMMED PINE TREES MIMIC STONEHENGE!
- ✓ PHOTO OPPS!
- ✓ TOURISM REVENUE!

INVENTION OF THE DAY

VERTICAL TREADMILL FOR INDOOR CLIMBERS!

BRILLIANT!



~15 FT.

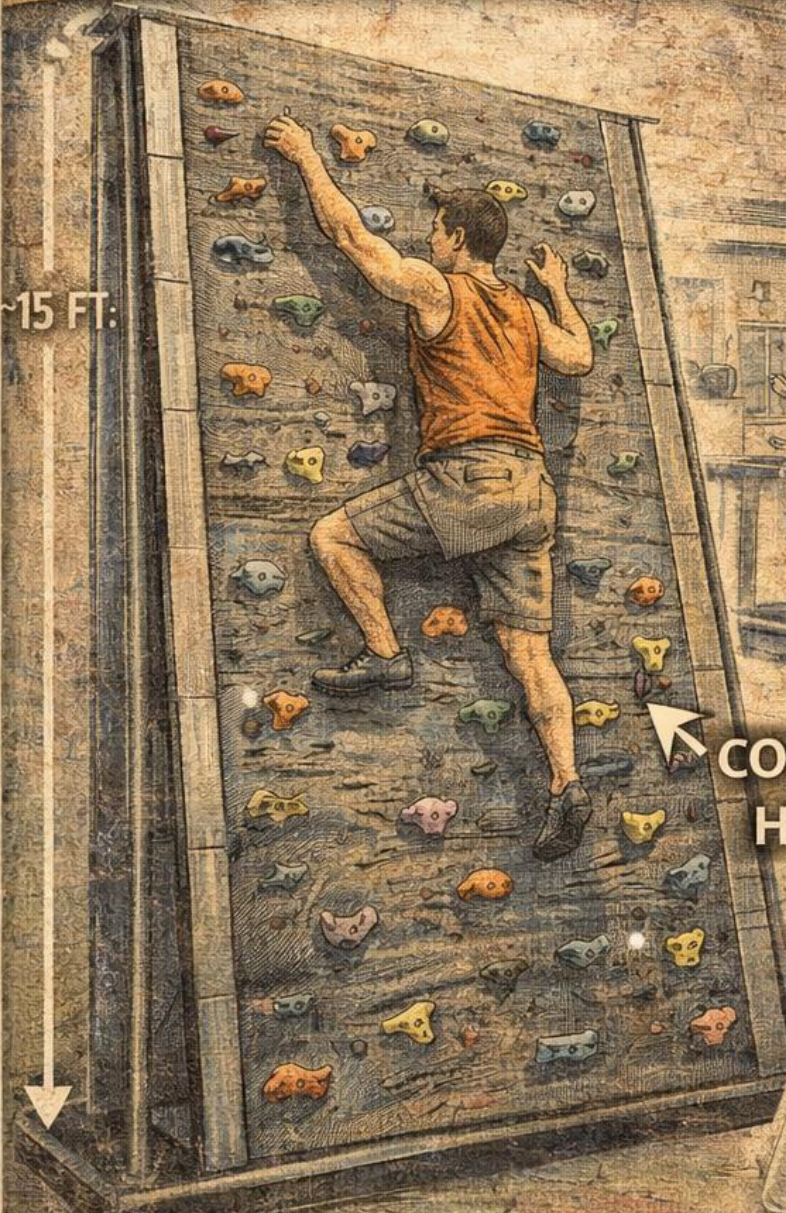

CONTINUOUSLY MOVING HAND AND FOOT GRIPS!



- SET THE DIFFICULTY!
- KEEP MOHEE OUTSIDE THE...

INDOOR CLIMBING AVAILABLE ANYWHERE!

INVENTION OF THE DAY

PORTABLE UV BUG ZAPPER!

NO TOXIC SPRAY NEEDED FOR BUG RELIEF!

Zap bugs
anywhere!

POWERFUL
UV LIGHT!

ELECTRIC
SHOCK
GRID!

RECHARGEABLE
BATTERY!



TE'S BUG OU:DOORS!

BY THE CAMPFIRE

ON A HIKE

IN HOTELS

**BUG-FREE
OUTDOORS!**

-  uses a UV light to attract insects
-  kills 'em efficiently with electric shock.
-  relieves without needing toxic spray!

INVENTION OF THE DAY

NUMBERED FUEL PUMP HANDLES!

NOW IT'S EASY TO GIVE THE PUMP NUMBER!

It's rgiht there on the handle so you don't gotta remember squat!



3 CLEAR NUMBERS

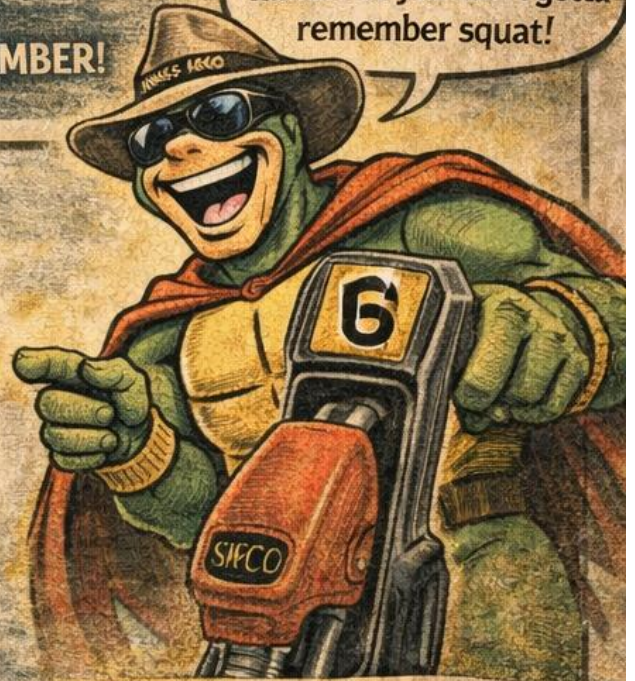

7 CAN'T MISS 'EM!

BEFORE

Uh, it was the blue car...I think...
2nd from the end maybe...

AFTER

ITS PUMP#6!

**NO MORE
"UH, I THINK IT WAS..."**



INVENTION OF THE DAY

BEER DUI SMART WATCH!

BEER COUNTER & ACCOUNT PROTECTOR!

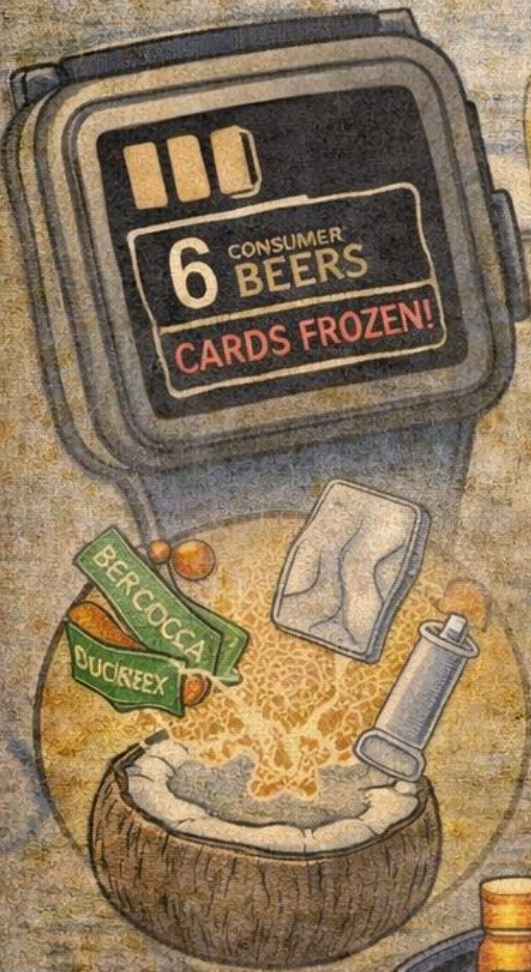

- ✓ FREEZES CARDS WHEN YOU'VE HAD TOO MUCH!
- ✓ COUNTS YOUR BEERS!
- ✓ LET'S TRY THE NEW BEVERAGE!



**IT'S
GOT LEGS!**

INVENTION OF THE DAY

NEW FEIJOA!

NOW WITH NO WEIRD AROMA!

Tastes delicious,
no stinky odor!

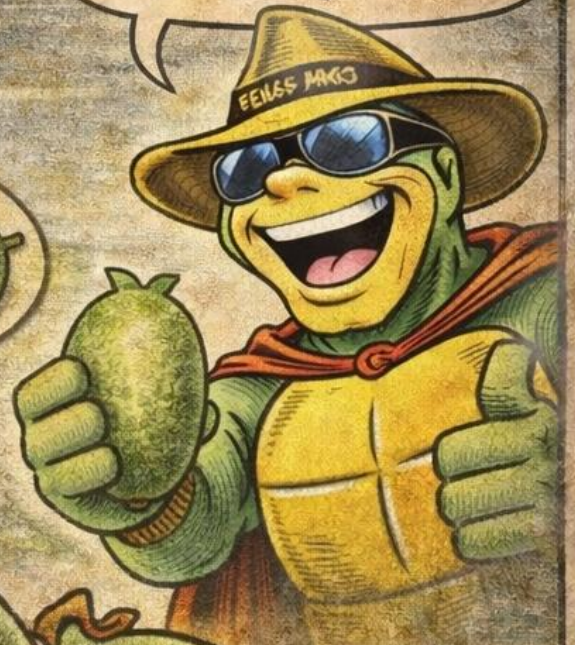

**FEIJOA
REINVENTION!**

- ✓ FEIJOAS WITHOUT THE FUNKY FLAVOR!
- ✓ SMELLS GREAT, TASTES GREAT!
- ✓ PERFECT FOR PICKY EATERS!

INVENTION OF THE DAY

★ LOSING CASINO!

A CASINO THAT ALWAYS LOSES
★ SO YOU ALWAYS WIN! ★

THE HOUSE ALWAYS
LOSES!

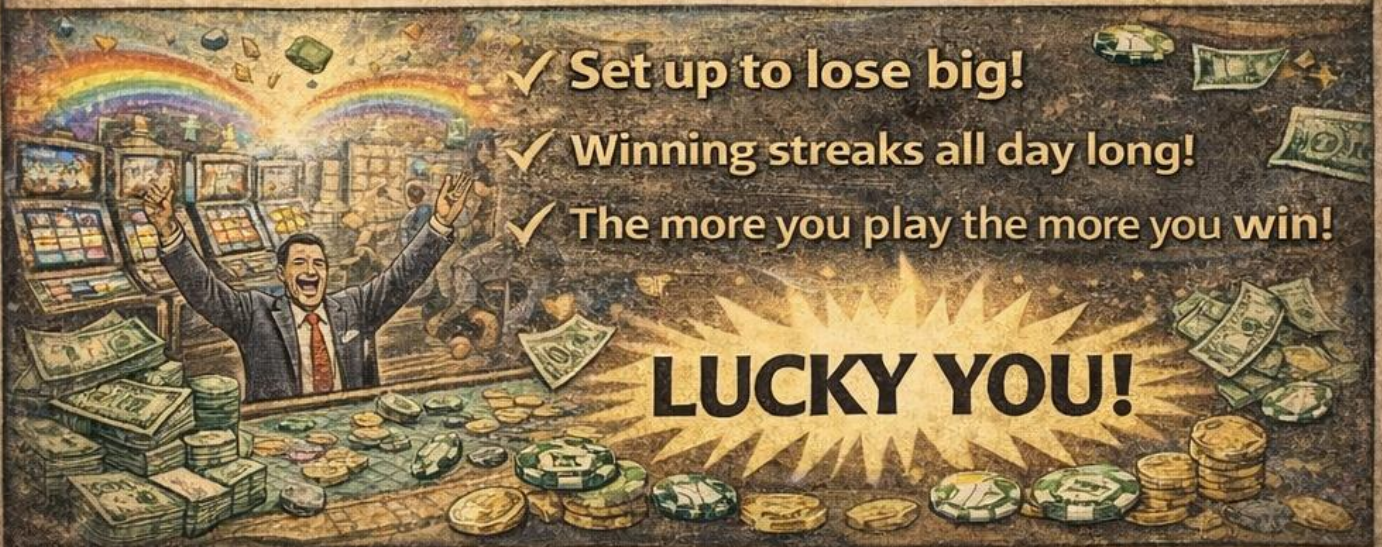

INVENTION OF THE DAY

THE COLD SLING®

TISSUE-PACKING CONVENIENCE!

Tissue-packing
Convenience!

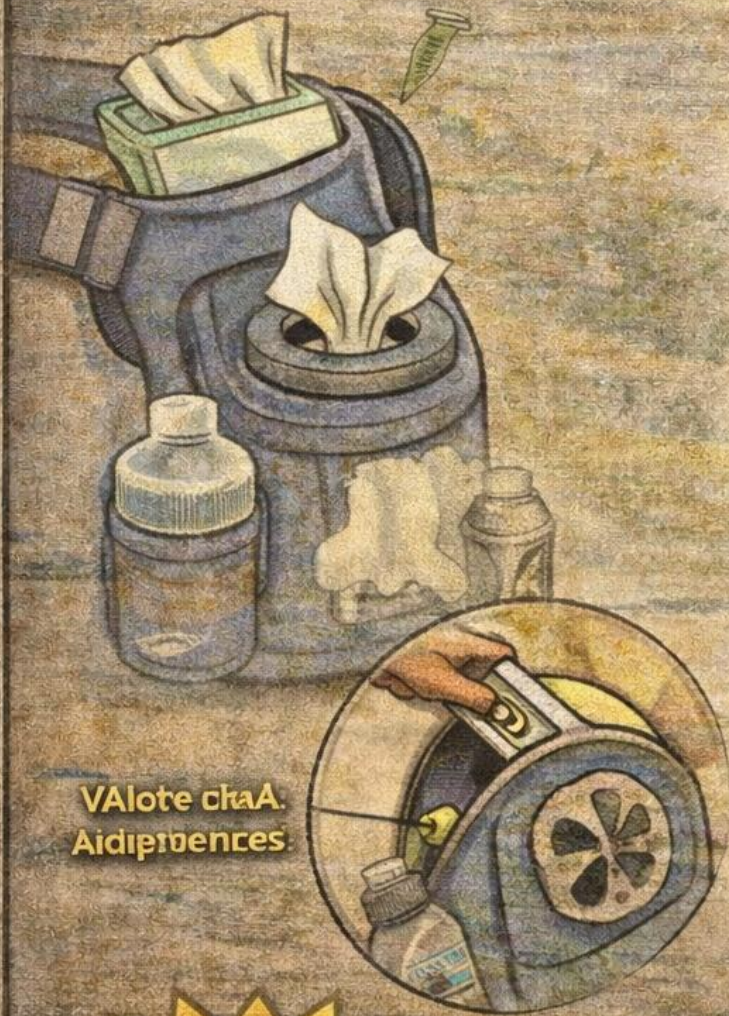

VALote ckaA.
Aidipnences

**THE
COLD SLING®**

- ✓ TISSUES AT HAND & DISPOSAL ON THE GO!
- ✓ DISPOSABLE BAG FOR USED TISSUES!
- ✓ CONTAINS EXTRA COLD RELIEVERS!

INVENTION OF THE DAY

VAPE PIPE!

ALL THE NICOTINE BUT CLASSIER!

You'll look CLASSY AS HELL!

You'll look CLASSY AS HELL!

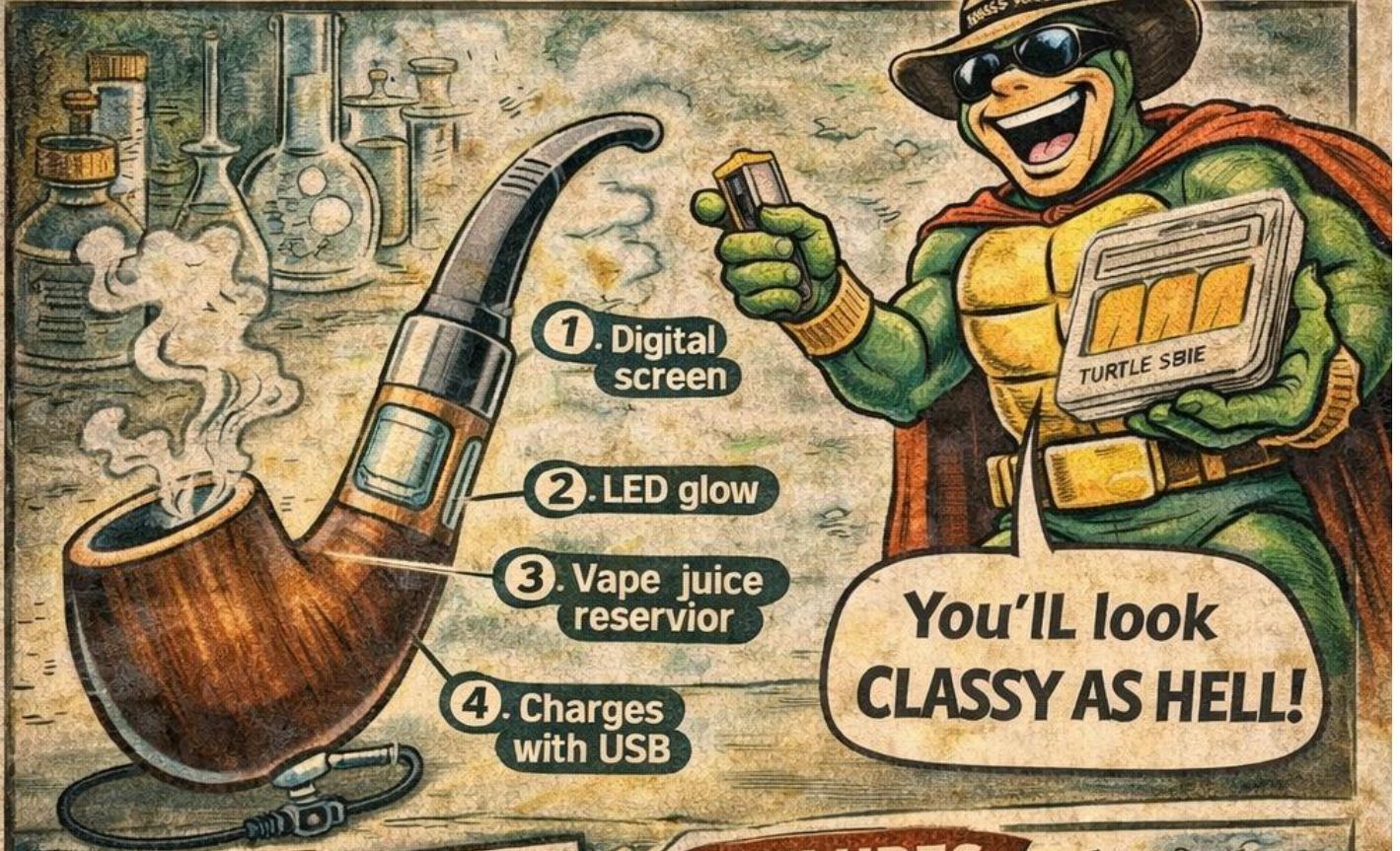

1. Digital screen

2. LED glow

3. Vape juice reservoir

4. Charges with USB

FAILURES

- Disliked by pipe purists
- Some other messages Don't translate well
- Might explode



TRADITIONAL PIPE



Smell of old man's house

Smell of vanilla candy cotton



REGULATOR APPROVED*

Cyber-analogue Science

- **Mechanism:**
 - Laws around tobacco marketing loophole
 - Also works for cannabis
 - Feels cool as fuck



INVENTION OF THE DAY

PYRO-VAC!

NEVER EMPTY YOUR VACUUM AGAIN!

Turns out ash is a vacuum's best friend!

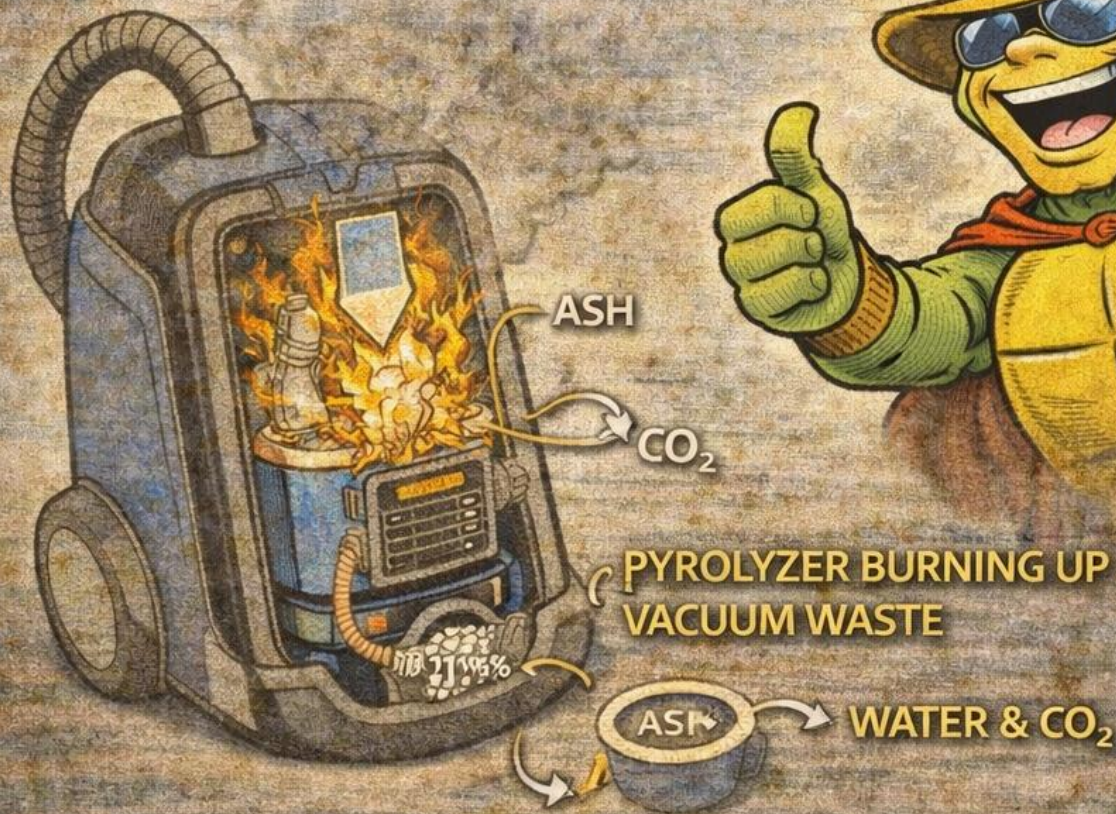

LASTS FOREVER!

- ✓ CONSUMES ALL ORGANIC WASTE!
- ✓ NEXT TO NO ASH REMAINS!
- ✓ REPLACE THE VACUUM BEFORE THE BAG IS FULL!

INVENTION OF THE DAY

GOOGLE FACTS!

THE ALL-KNOWLEDGE WEBSITE! "

Google wutt lbilk,
the wiw proeate!

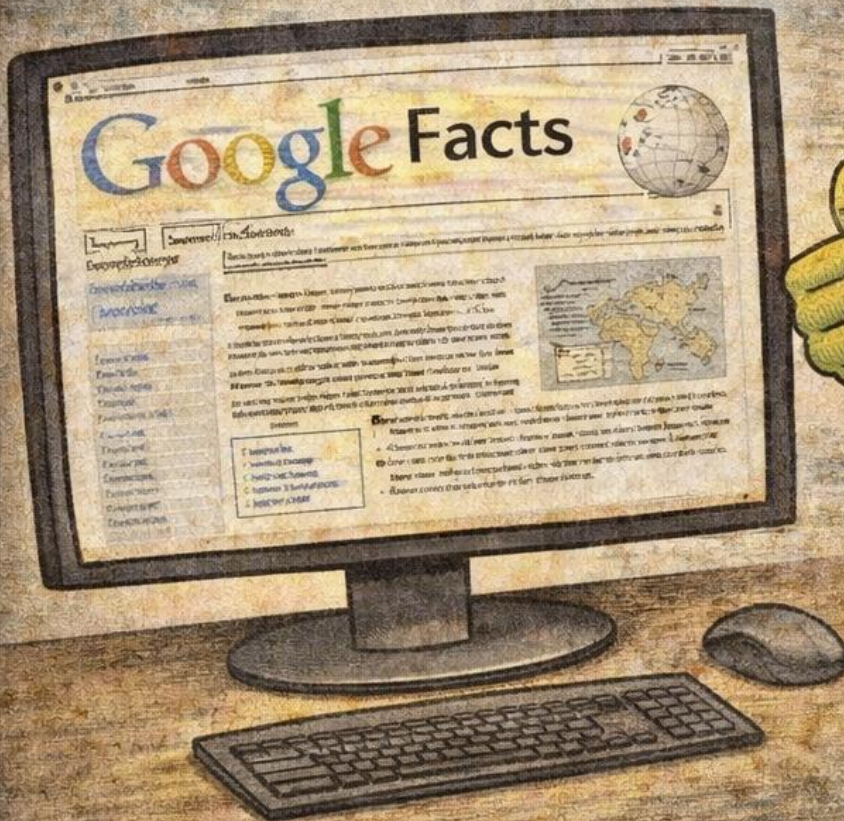

**FUN
TURTLE FACT!**
ALL TURTLES
ARE REPTILES!

- ✓ EVERYTHING LICENSED FROM WIKIPEDIA!
- ✓ INFINITE KNOWLEDGE AT YOUR FINGERTIPS!
- ✓ USEFUL FOR ALL OCCASIONS!

INVENTION OF THE YEAR

HOMEOPATHIC PERFORMANCE, ENHANCING DRUGS!

ENHANCE PERFORMANCE,
WITHOUT A TRACE

Magically undetectable!

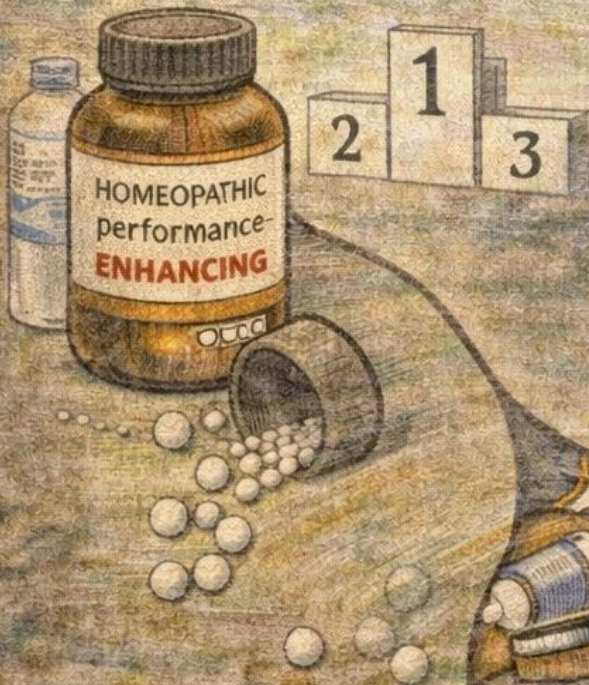
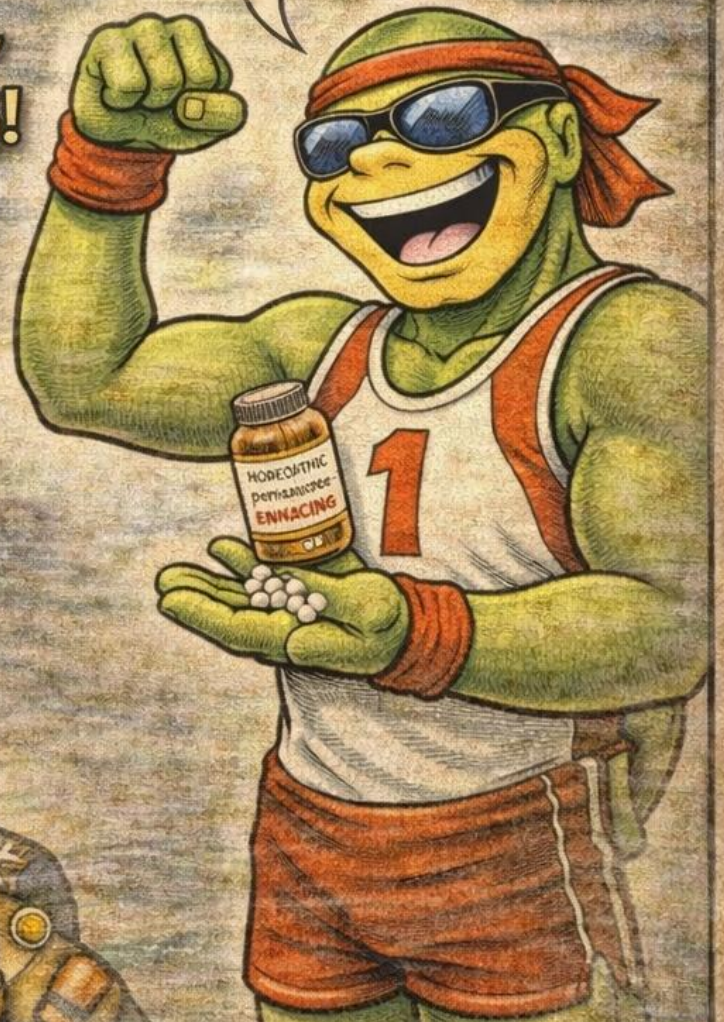

**PASS
ANY TEST!**

- ✓ COMPLETELY UNDETECTABLE!
- ✓ NOSIDE EFFECTS!
- ✓ MORE NATURAL THAN EVER!

INVENTION OF THE DAY

BRAIN-MONITORING IN-EAR HEADPHONES!

TRACK YOUR MOODS & MORE!

IT CHECKS OUT!

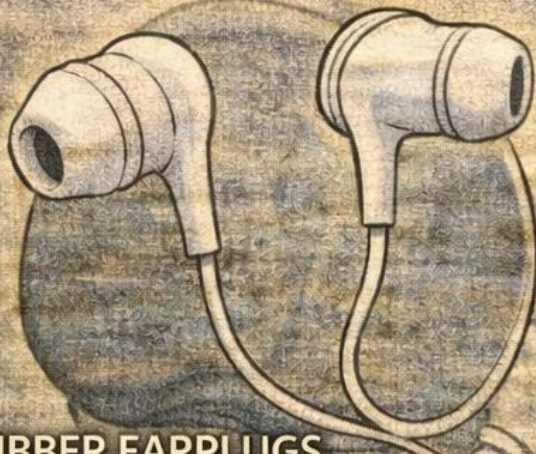

RUBBER EARPLUGS
WITH MICROWIRE ELECTRODES

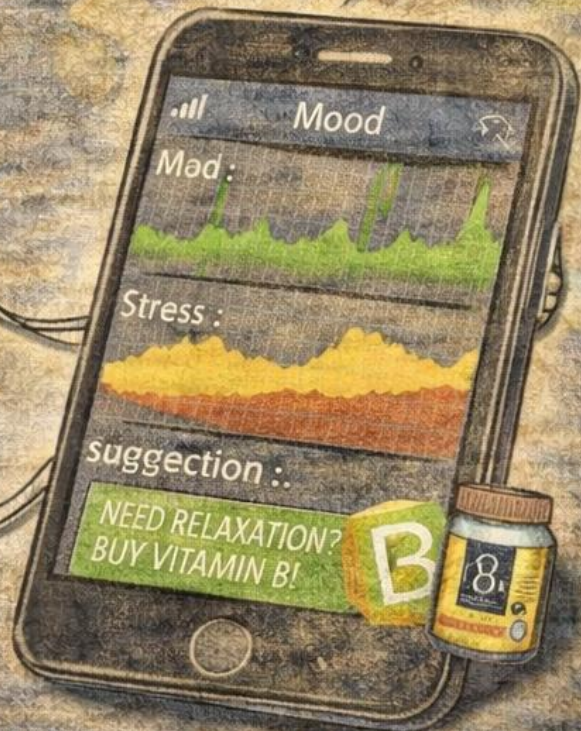

**LASTS
FOREVER!**

- ✓ MONITORS YOUR BRAIN ACTIVITY
- ✓ DETECTS STRESS, MOODS, & MORE!
- ✓ OFFERS USERS "HELPFUL" PRODUCTS



INVENTION OF THE DAY

DRONE MERANG!

IT RETURNS... WITH BUILT-IN DRONE TECH!

Never lose your boomerang again!



GPS TRACKER!



ADJUSTS FLIGHT PATH!

HOVERS BACK TO YOU!

**AUTOMATIC
BOOMERANG
RECOVERY!**

- ✓ BUILT-IN GPS & DRONE PROPULSION!
- ✓ GUARANTEED TO RETURN TO THROWER!
- ✓ NEVER LOSE YOUR BOOMERANG!

INVENTION OF THE DAY

CACTUS GARDEN HAT!

GROW CACTI ON YOUR HEAD!



GROW CACTI ON YOUR HEAD!

Two hot inventions!



GREEN UP YOUR STYLE!



See perfectly close-up!

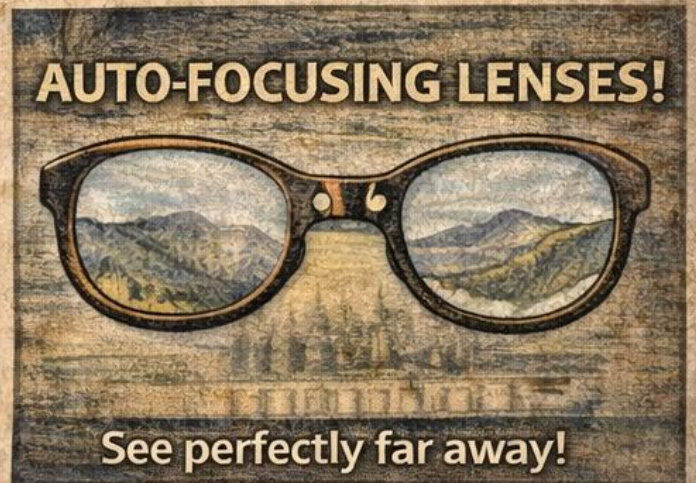

AUTO-FOCUSING LENSES!

See perfectly far away!

**TWO INVENTIONS
IN 1 AD!**

- ✓ GROW CACTI ON YOUR HEAD!
- ✓ ADJUSTABLE FOCUS GLASSES!

GLASSES ADJUST FOCUS
WHEREVER YOU'RE LOOKING!



INVENTION OF THE DAY

EARPLUGS DOPED WITH THAT STUFF THEY USUALLY PUT IN SKIN PATCHES!



NOW THE EAR CANAL CAN DELIVER DRUGS TO THE BODY!

"NOW THE EAR CANAL CAN DELIVER DRUGS TO THE BODY!"

DRUGS DIFFUSE TO THE BLOODSTREAM

FENTANYL
NICOTINE
PATCH

CLEAR TIMES

VS

DOSED
EARPLUGS

FAILURES

- Wax blockage
- Falls out
- Nothing happens
- **WAY TOO MUCH!**

MML EARPLUG

● **Mechanism:**

- Diffuses drugs through vascularised ear canal skin
- Includes nicotine, fentanyl, and others.
- Dose control dial for... some reason

★ ★ ★

REGULATOR APPROVED*

© 2010 MML EARPLUG

INVENTION OF THE DAY

VOICE-ACTIVATED TOILET!

-15 FT



WOW!



- CONTROL FUNCTIONS BY SOUND!
- USE AN APP TO CUSTOMIZE COMMANDS!



INDOOR CLIMBING AVAILABLE ANYWHERE!

INVENTION OF THE DAY

LOCK-SLIDER REMOTE!

NO MORE ACCIDENTALLY TURNING OFF THE TV!

Locks your remote so nothin' ghosts the TV off!



SLIDE TO LOCK!



1. Stops pets from stepping on the power button
2. Blocks couch potato love handles
3. Prevents sleepy misfires!

NO MORE BUTTON HAUNTINGS!

1. STOPS PETS FROM STEPPING ON THE POWER BUTTON



2. BLOCKS COUCH POTATO LOVE HANDLES



3. PREVENTS SLEEPY MISFIRES!



NO MORE BUTTON HAUNTINGS!



INVENTION OF THE DAY

DUAL-SCREEN SMARTPHONE

A DISPLAY ON BOTH SIDES! BECAUSE ONE JUST WASN'T ENOUGH!

Usual full-color
OLED DISPLAY



Flip over to switch
screens!

TURN IT AROUND
TO SAVE YOUR
BATTERY!



Bright color,
photos and videos

e-Ink style
DISPLAY FOR
BRIGHT SUNLIGHT!

OLED DISPLAY ➔ Cuts battery use by up to 80%!

OLD PHONE



- Fan blows outside
- Uses less power
- Great everywhere.

DUAL-SCREEN PHONE *



★★★ **REGULATOR APPROVED*** #C

Mechanism:

- Flip back and forth between both displays.
- Use e-ink display outside for efficiency
- The sun is really bright.

Signature

INVENTION OF THE DAY

INSTITUTE OF NATURAL INTELLIGENCE INI

VOCATIONAL TRAINING - AN AI-PROOF FUTURE

Work in a job that's hard for robots to replace!

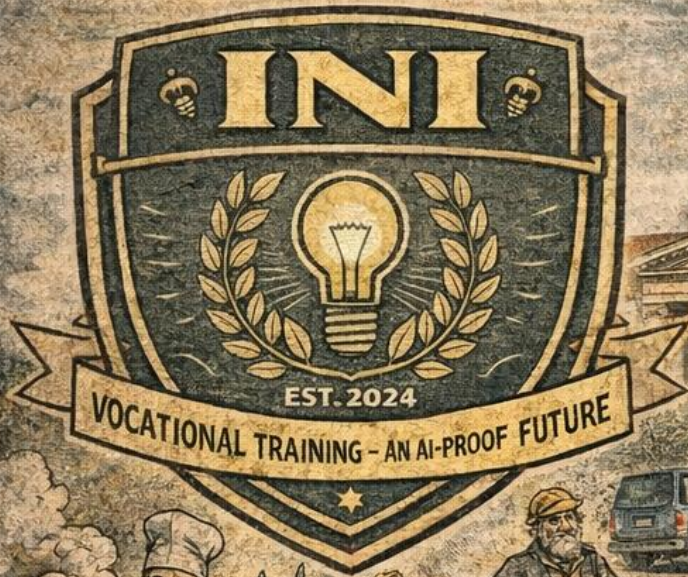

- ✓ **AI RESISTANT**
Real human skills that robots can't replace.
- ✓ **JOB SECURITY**
Excellent employment in unpredictable times
- ✓ **FOUR-LEGGED PROFESSORS!**
Quirky academics who can't get replaced by AIs.



Electrical Work

Plumbing

Massage Therapy

TRAINING HUMANS FOR JOBS THAT RESIST AI AND ROBOTS!

ELECTRICAL WORK



Electrical Work

PLUMBING



Plumbing

MASSAGE THERAPY



Massage Therapy

INVENTION OF THE DAY

CHOPSTICK CIGARETTE HOLDER!

AMAZING!



- KEEP SMOKE OUTSIDE THE CAR!
- NO MORE SALTY ASH TRAY!



SOFT FEET MEET HARDWOOD AESTHETIC!

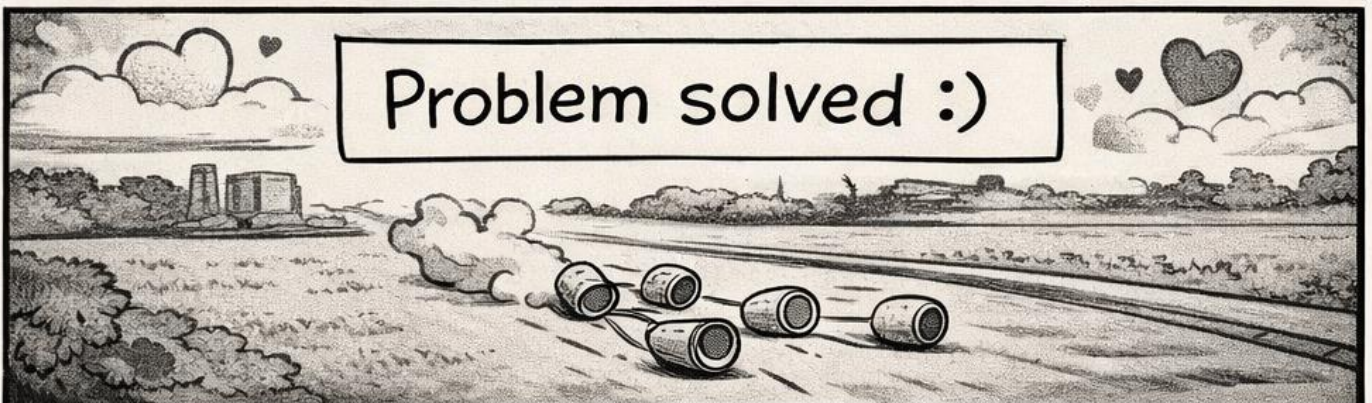
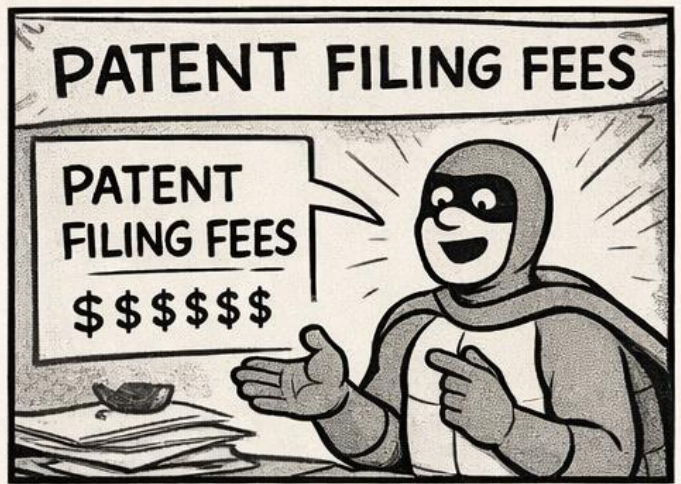

TURTLEWOMAN SAVES THE PLANET

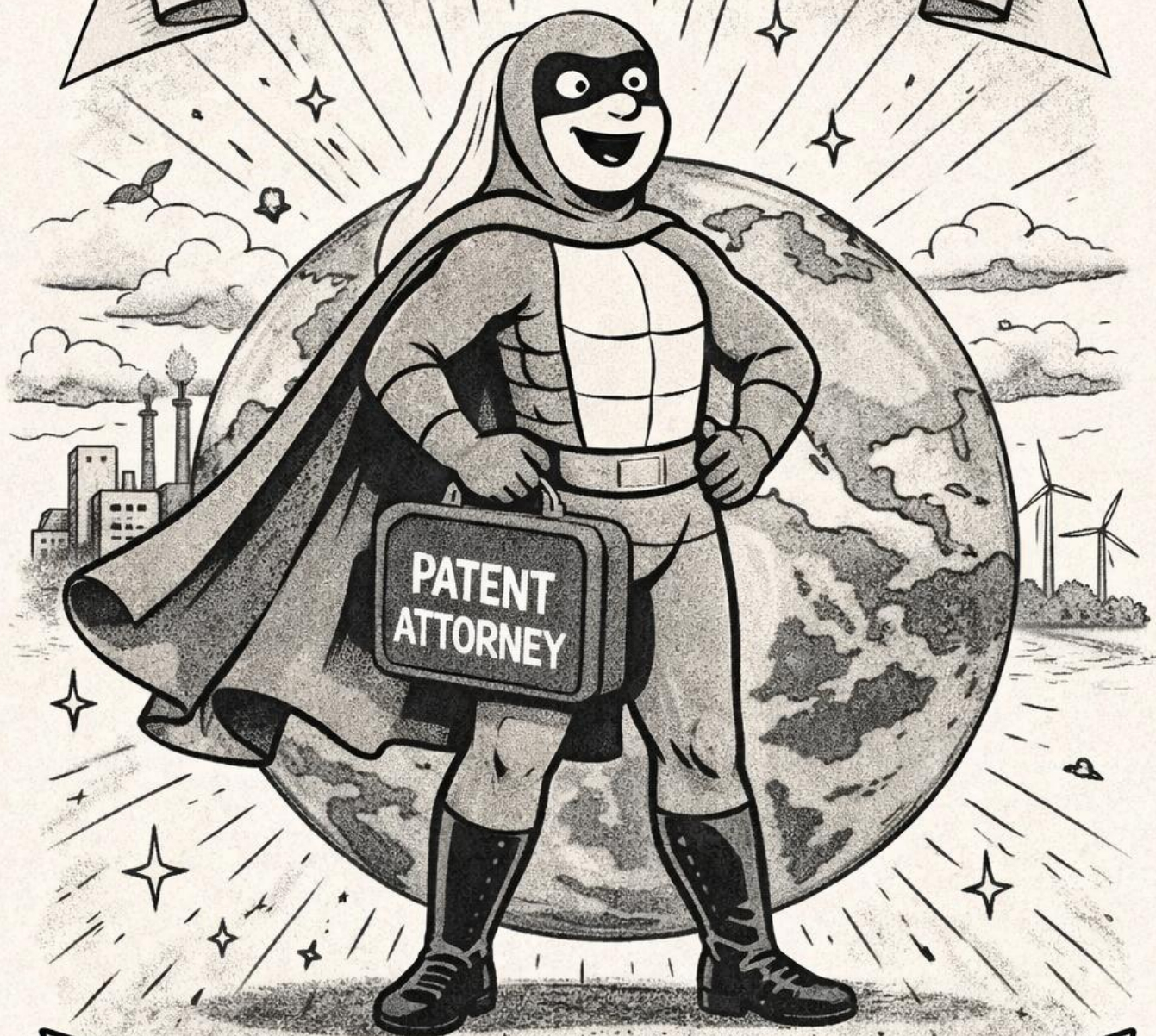

ONE PATENT AT A TIME